

Neutrino Masses in Cosmology

Miguel Escudero Abenza

miguel.escudero@cern.ch

**43rd School Neutrinos in Cosmology,
in Astro-, Particle- and Nuclear Physics**

Erice

21-09-2022



Motivation

- Neutrino masses are the only laboratory evidence of physics beyond the Standard Model
 - Use neutrinos to understand open problems in Cosmology
- Neutrinos are ubiquitous in Cosmology

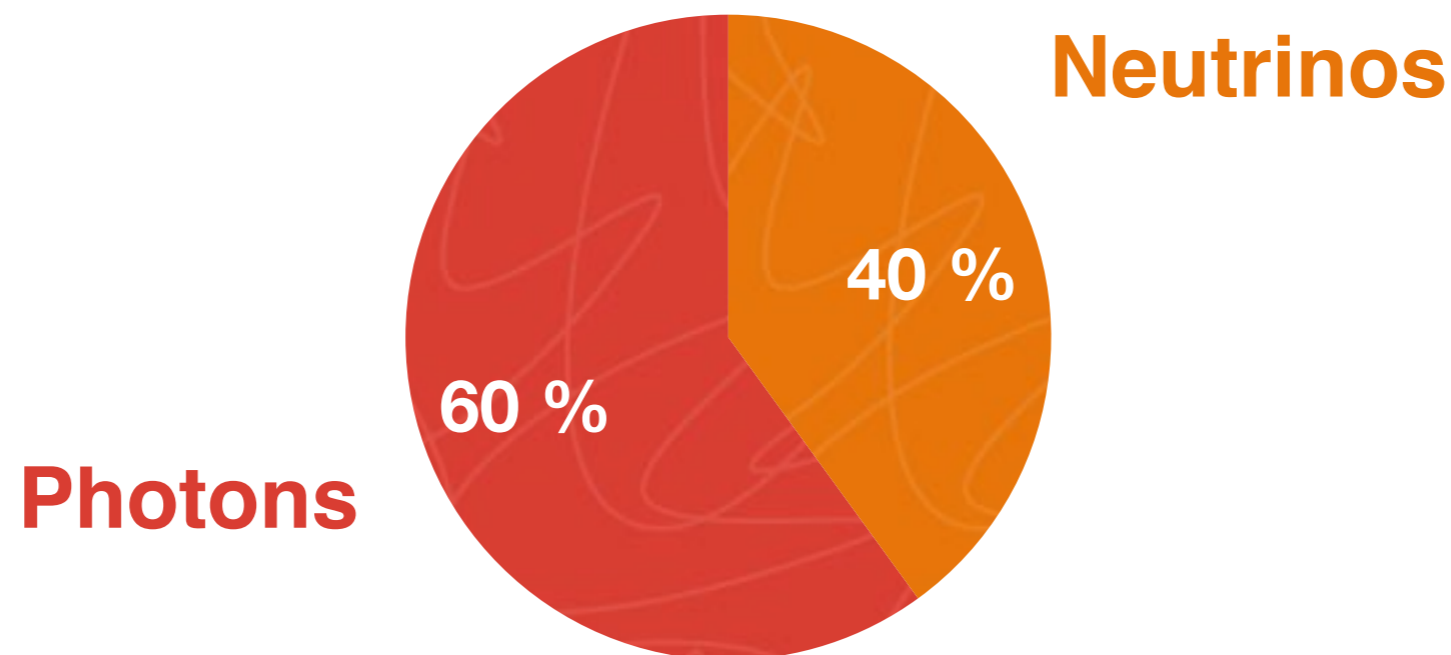

Use cosmological data to understand their properties

This lecture:

$$m_\nu$$

Goals

- 1) Review what is the role played by neutrinos in Cosmology**
- 2) Understand why one can derive neutrino mass bounds using cosmological data**
- 3) Understand what are the assumptions behind these cosmological neutrino mass bounds**
- 4) What are we going to learn in the upcoming years?**

Set Up

Unlike neutrinos, I like to interact 😊

The plan is to learn and discuss. Therefore:

**Questions and Comments
are most welcome, at any
time!!!!**

Crash course on early Universe cosmology

Evidence for the Cosmic Neutrino Background

Neutrino Mass Bounds in the Standard Cosmological Model

Neutrino Mass Bounds beyond Λ CDM

A 1-slide Cosmo Crash Course

Homogeneity and Isotropy implies Expansion!

- An homogeneous and isotropic Universe expands
- We have evidence that the early Universe was indeed fairly homogeneous and isotropic because $\Delta T_\gamma / T_\gamma \sim 10^{-4}$
- General Relativity relates the expansion rate of the Universe with the energy density in all the species contained on it

$$G_{\mu\nu} = 8\pi G T_{\mu\nu}$$



Friedmann Equation:

$$H^2 = \frac{8\pi G}{3} \rho$$

H : Expansion rate
(Hubble parameter)

ρ : Energy density

On the Standard Model of Cosmology:

Λ CDM \equiv Universe currently dominated by a Cosmological Constant and with Cold Dark Matter

New Laboratory Neutrino Mass Bound

KATRIN experiment

for details see talks by Alexey Lokhov
and Alessandro Schwemmer today!

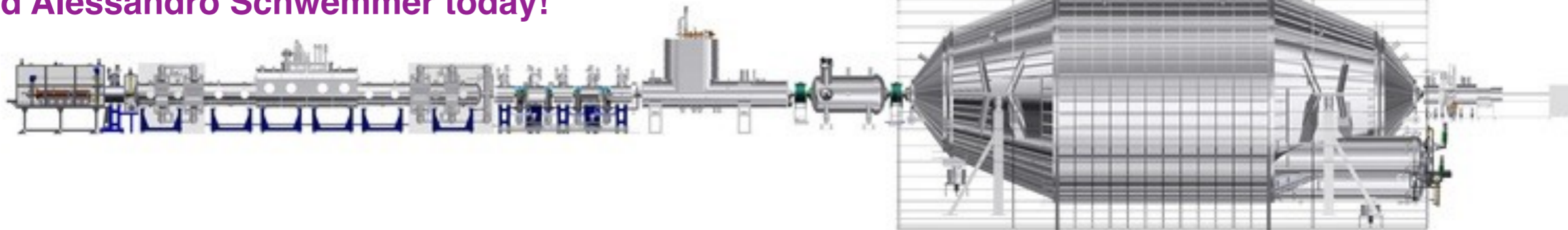

Mainz and Troitsk (2004):

$$m_{\nu_e} < 2.2 \text{ eV} \quad (95 \% \text{ CL})$$

Current laboratory bound:
2105.08533+1909.06048 (PRL)

$$m_{\nu_e} < 0.8 \text{ eV} \quad (90 \% \text{ CL, FC})$$

$$\sum m_\nu < 2.4 \text{ eV} \quad (90 \% \text{ CL, FC})$$

KATRIN expected reach
(in ~4 years)

$$m_{\nu_e} < 0.2 \text{ eV} \quad (90 \% \text{ CL})$$
$$\sum m_\nu < 0.6 \text{ eV}$$

Planck Legacy Data is Public

Planck Likelihoods 1907.12875

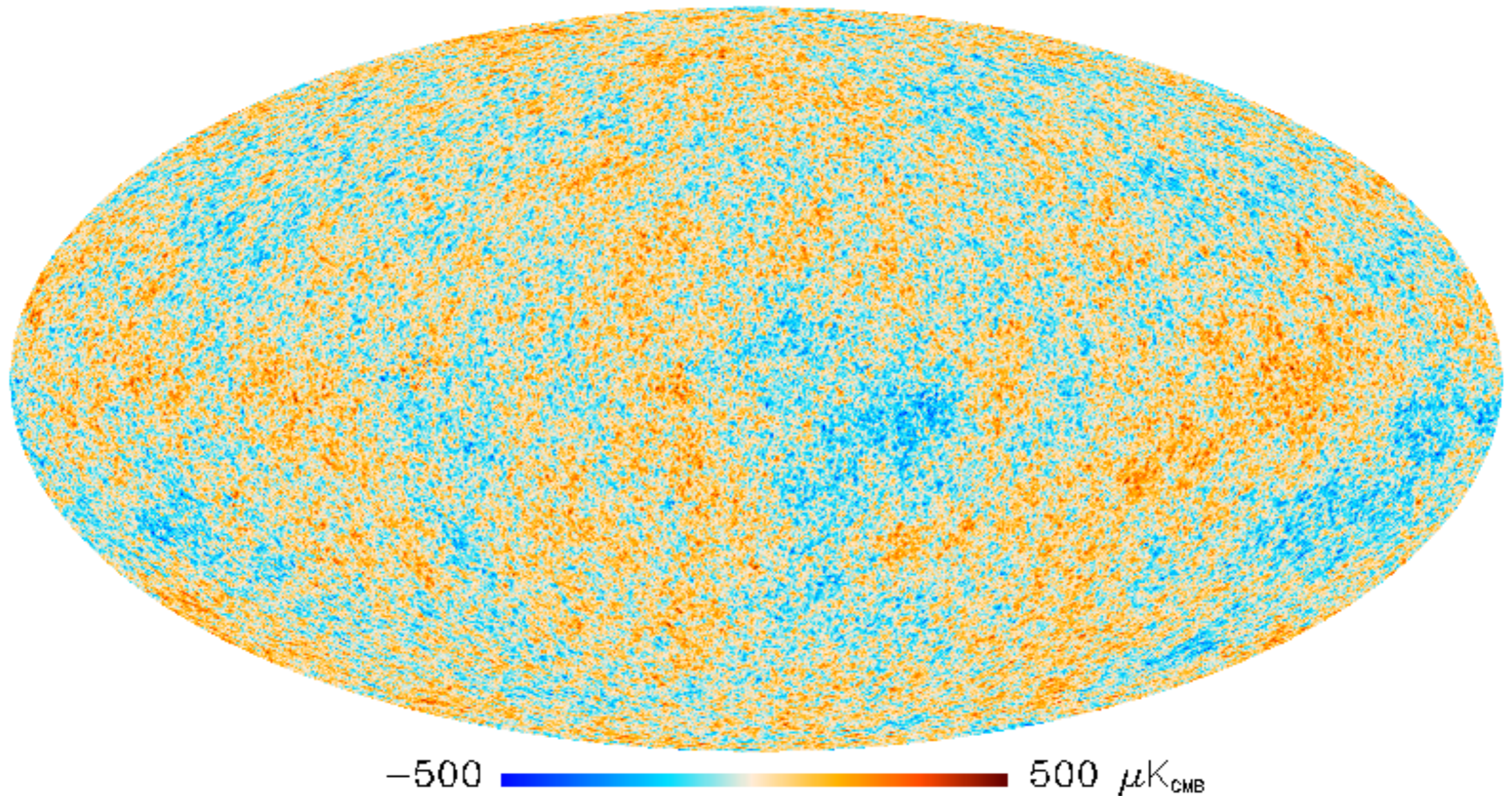

CLASS/CAMB MontePython/CosmoMC

Neutrino Decoupling

Evolution in the Standard Model

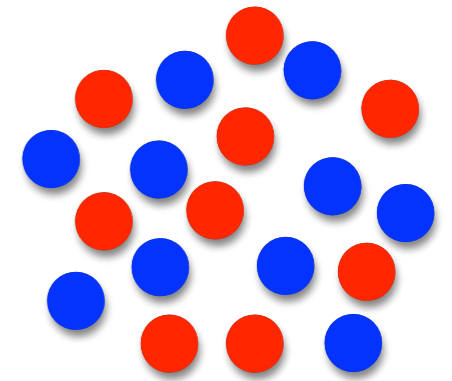
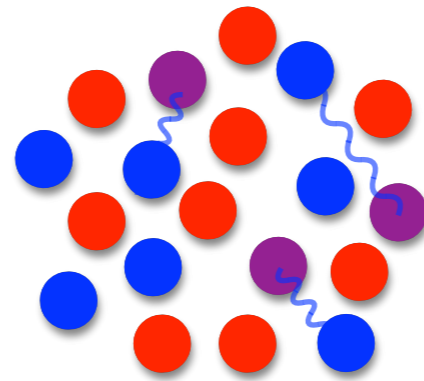
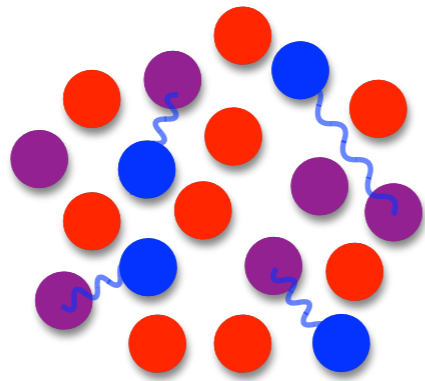
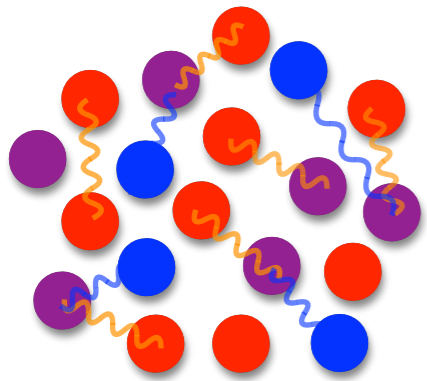
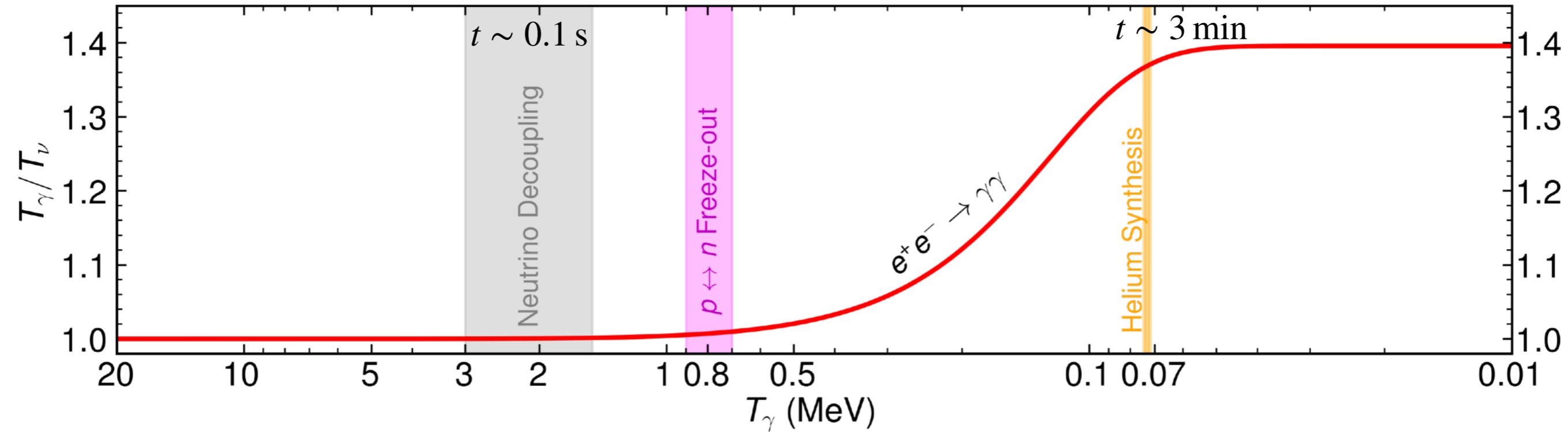

$$e^+ e^- \leftrightarrow \bar{\nu}_\alpha \nu_\alpha$$

$$e^\pm \nu_\alpha \leftrightarrow e^\pm \nu_\alpha$$

$$\nu_\alpha \nu_\beta \leftrightarrow \nu_\alpha \nu_\beta$$

● **Neutrinos**
 ● **Electrons**
 ● **Photons**
 ~ **Z-W (off-shell)**

Neutrino Decoupling

Evolution in the Standard Model

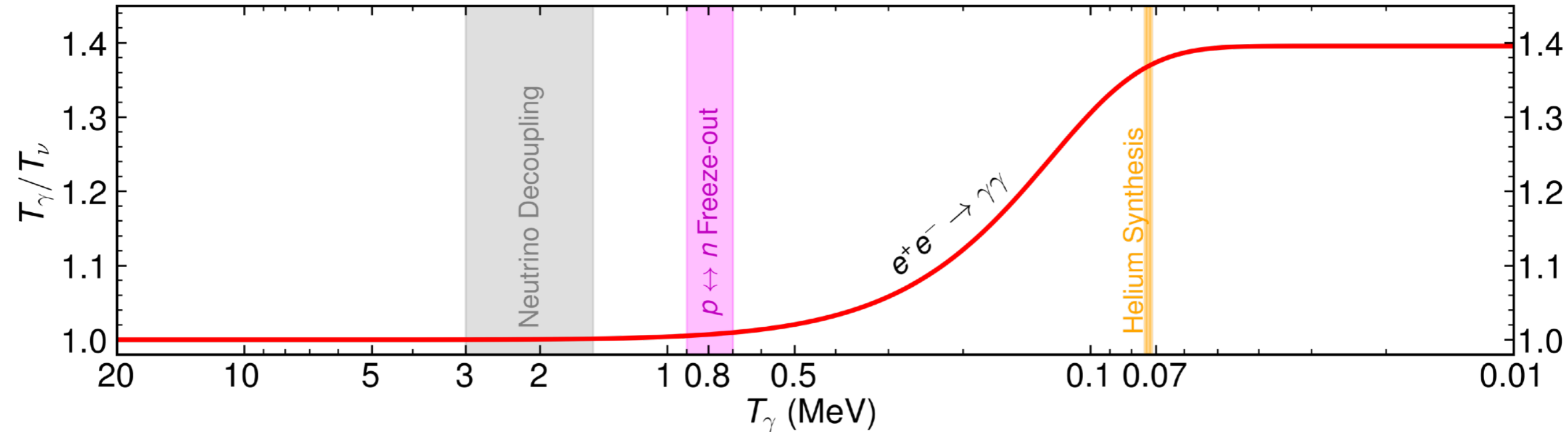

- How do we measure the energy density in relativistic neutrino species?

- The key parameter is:
$$N_{\text{eff}} \equiv \frac{8}{7} \left(\frac{11}{4} \right)^{4/3} \left(\frac{\rho_{\text{rad}} - \rho_{\gamma}}{\rho_{\gamma}} \right)$$
- when only neutrinos and photons are present:
$$N_{\text{eff}} = 3 \left(\frac{1.4 T_{\nu}}{T_{\gamma}} \right)^4$$

- The Standard Model value is:
$$N_{\text{eff}}^{\text{SM}} = 3.044(1)$$

Bennett, Buldgen, Drewes & Wong 1911.04504
 Escudero Abenza 2001.04466
 Akita & Yamaguchi 2005.07047
 Froustey, Pitrou & Volpe 2008.01074
 Gariazzo, de Salas, Pastor et al. 2012.02726
 Hansen, Shalgar & Tamborra 2012.03948

Neutrino Evolution

Neutrinos are always a relevant species in the Universe's evolution

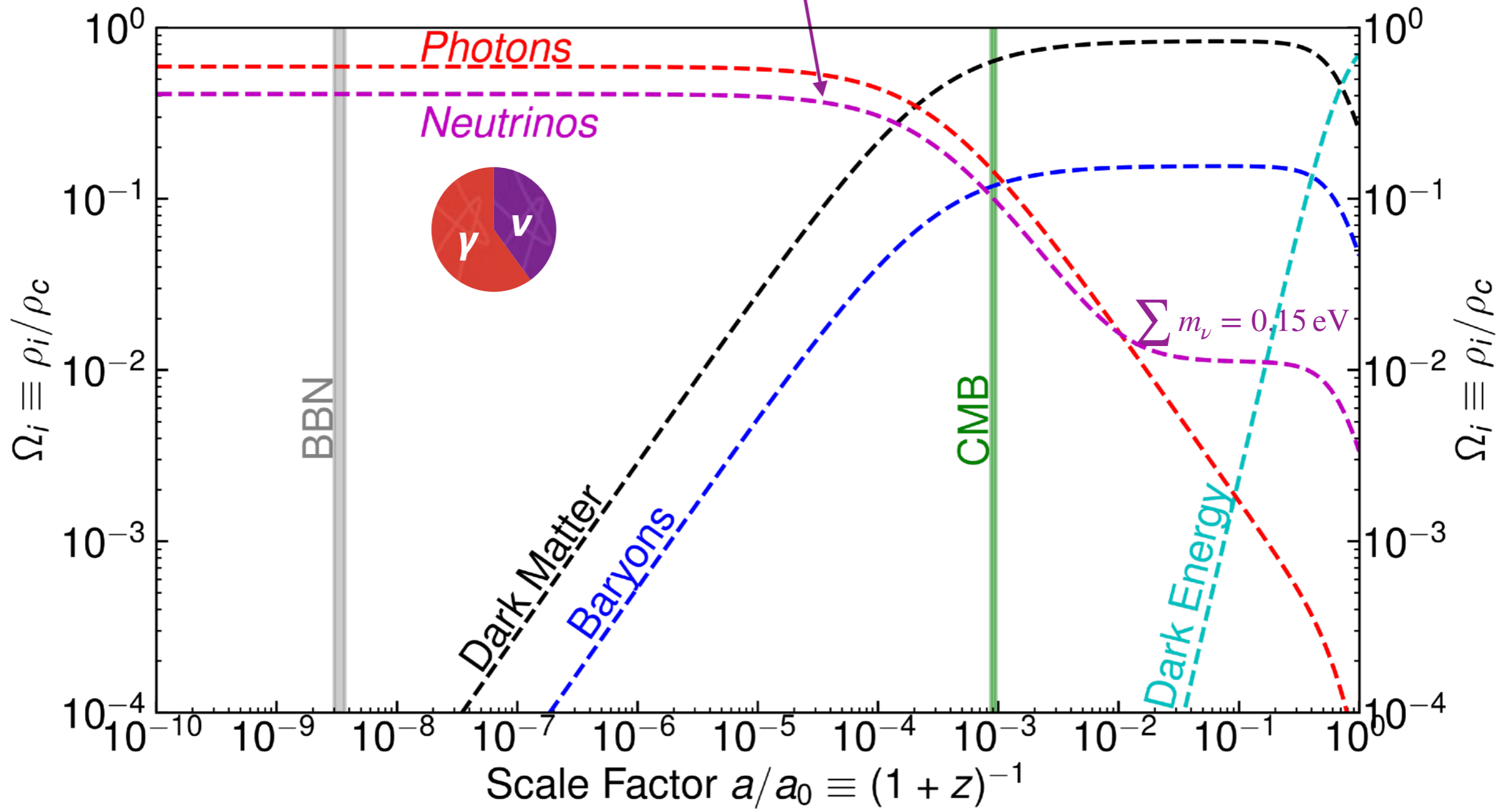

Non-Rel: $z_\nu^{\text{non-rel}} \simeq 200 \frac{m_\nu}{0.1 \text{ eV}}$

Hot DM: $\Omega_\nu h^2 = \sum m_\nu / (93.14 \text{ eV})$

Evidence for Cosmic Neutrinos

Big Bang Nucleosynthesis

Current measurements are broadly consistent with the SM picture

● H ~ 75%

●●●● ^4He ~ 25%

●● D ~ 0.005%

This implies that neutrinos should have been present:

1) It is impossible to have successful BBN without neutrinos. They participate in $p \leftrightarrow n$ conversions up to $T \gtrsim 0.7 \text{ MeV}$

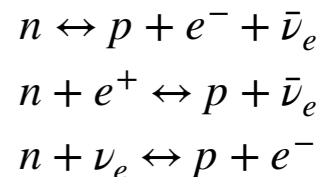

2) Neutrinos contribute to the expansion rate $H \propto \sqrt{\rho}$

By comparing predictions against observations, we know:

$$N_{\text{eff}}^{\text{BBN}} = 2.86 \pm 0.28$$

see e.g. Pisanti et al. 2011.11537

Evidence for Cosmic Neutrinos

Cosmic Microwave Background

Why?

Ultra-relativistic neutrinos represent a large fraction of the energy density of the Universe, $H \propto \sqrt{\rho}$

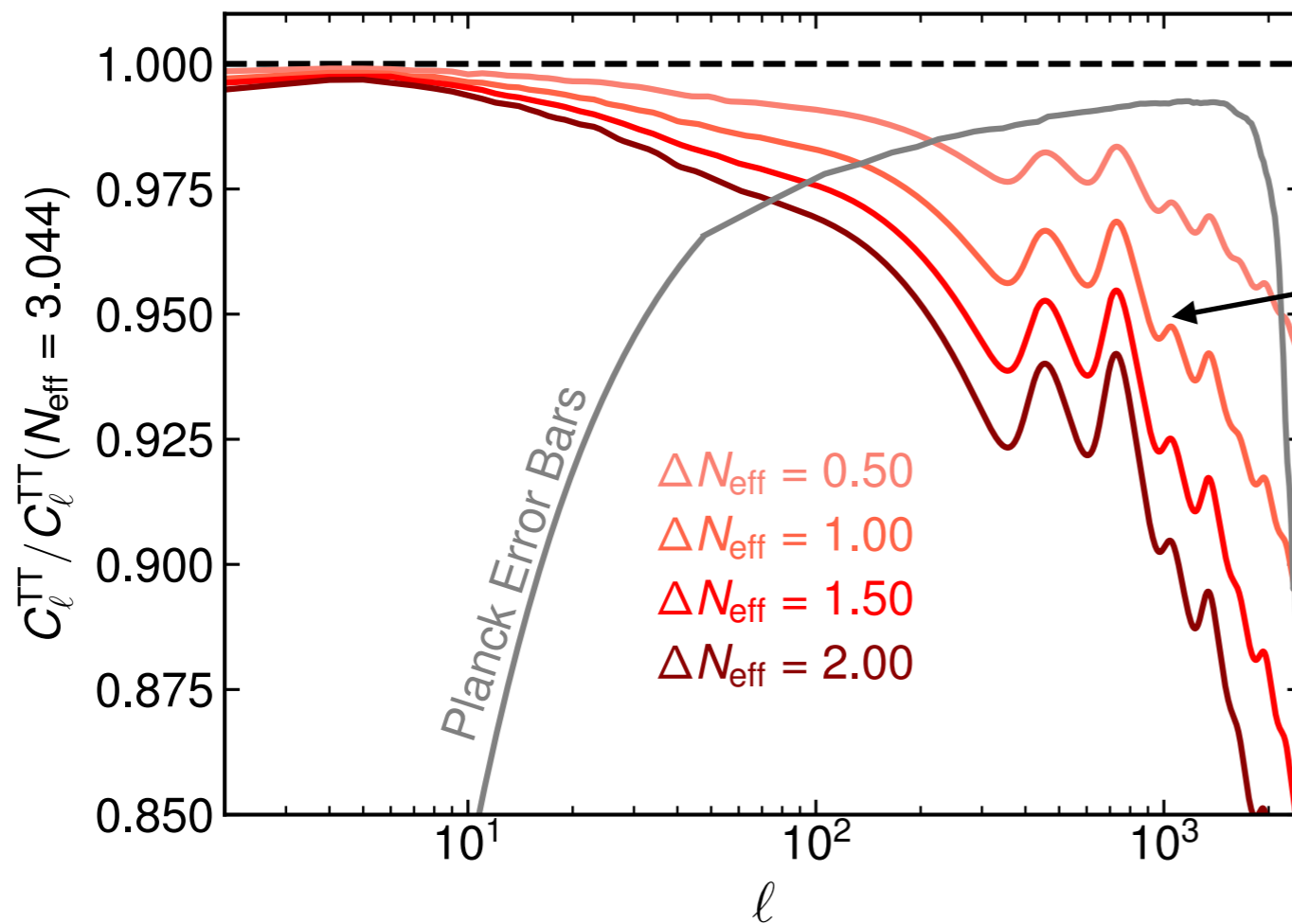
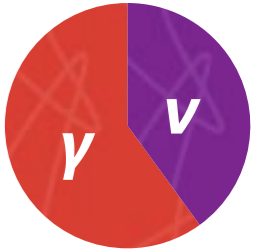

N_{eff} is constrained by the high- ℓ multipoles, i.e. Silk damping

$$N_{\text{eff}}^{\text{CMB+BAO}} = 2.99 \pm 0.17$$

Planck 2018 1807.06209

Evidence for Cosmic Neutrinos

- **Current constraints**

BBN

$$N_{\text{eff}}^{\text{BBN}} = 2.86 \pm 0.28$$

Pisanti et al. 2011.11537

Planck+BAO

$$N_{\text{eff}}^{\text{CMB}} = 2.99 \pm 0.17$$

Planck 2018, 1807.06209

- **Standard Model prediction:** $N_{\text{eff}}^{\text{SM}} = 3.044(1)$

- **Data is in excellent agreement with the Standard Model prediction**

- **This provides strong (albeit indirect) evidence for the Cosmic Neutrino Background.**

Implications:

1) **Stringent constraint on many BSM settings**

2) **We can use cosmological data to test neutrino properties**

Neutrino Properties

Figure from de Salas et al. 1806.11051

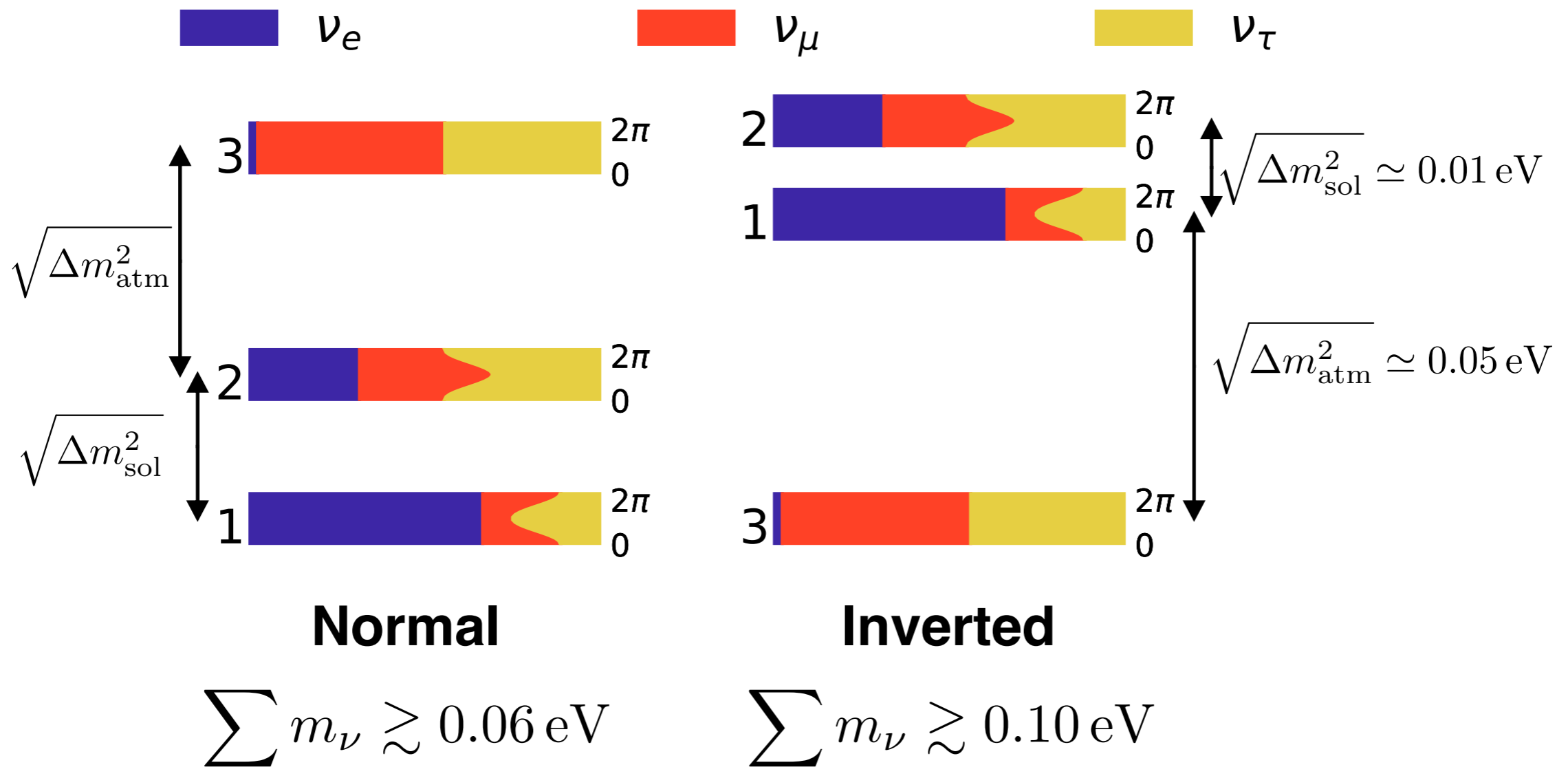

- Mass differences and mixings measured with high precision
- What is δ_{CP} and what is the mass ordering? [Neutrino Oscillations](#)
- Are Neutrinos Dirac or Majorana particles? [\$0\nu 2\beta\$ Experiments](#)
- What is the neutrino mass scale? i.e. $\sum m_\nu$? i.e. m_{lightest} ? [Cosmology](#)

Neutrino Masses in Cosmology

- 1) Massive neutrinos modify the expansion history

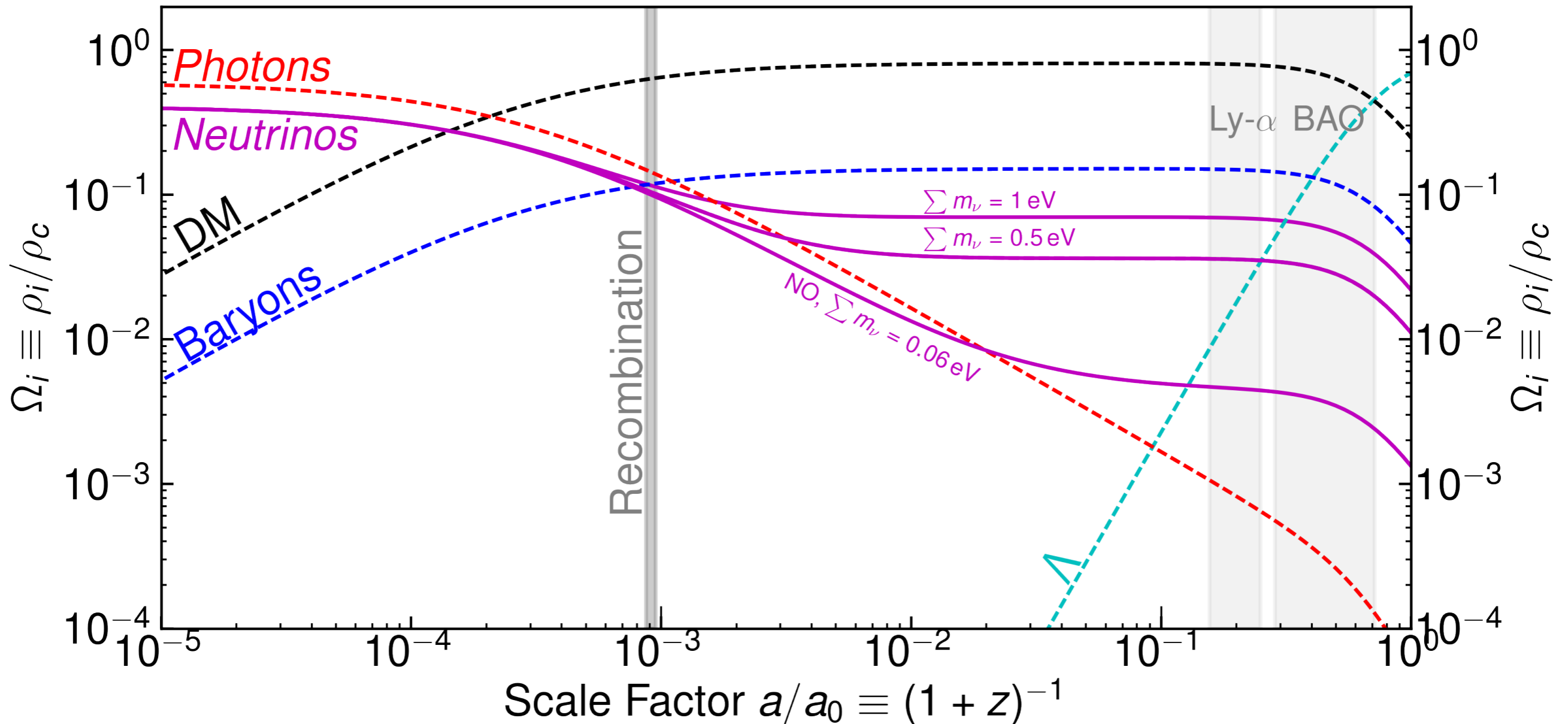

Non-Rel: $z_\nu^{\text{non-rel}} \simeq 200 \frac{m_\nu}{0.1 \text{ eV}}$

Hot DM: $\Omega_\nu h^2 = \sum m_\nu / (93.14 \text{ eV})$

Neutrino Masses in Cosmology

- 2) Massive neutrinos suppress the growth of structure

Taken from a talk by Steen Hannestad [Link](#).

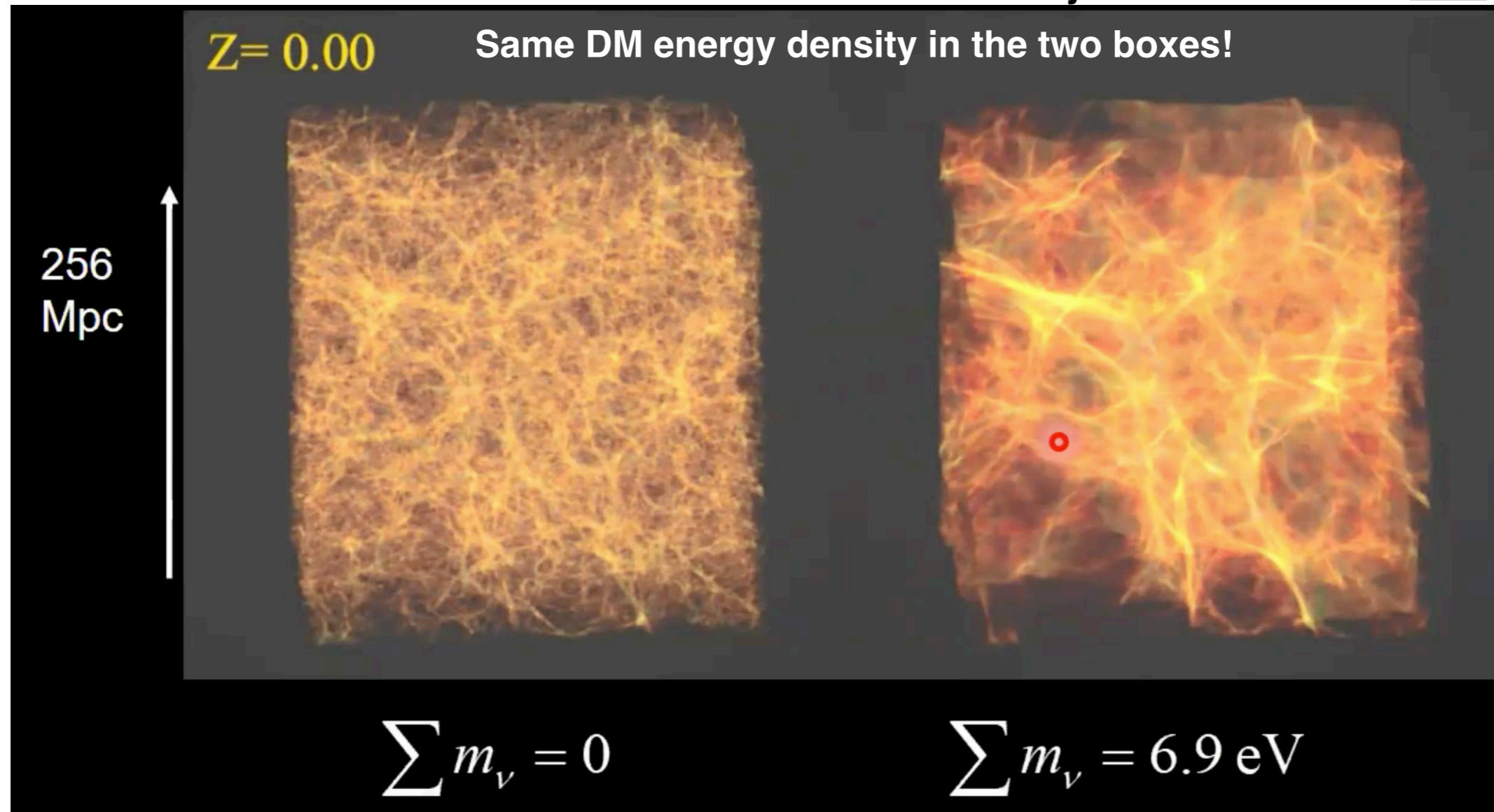

This happens because neutrinos travel very fast and therefore cannot fall in gravitational potentials. The effect of this smoothing is proportional to Ω_ν

Neutrino Masses in Cosmology

Cosmic Microwave Background Anisotropies

Neutrinos of $m_\nu < 0.5 \text{ eV}$ become non-relativistic after recombination. That means that their effect on the anisotropies is somewhat small!

The most relevant impact is through the effect of gravitational lensing:

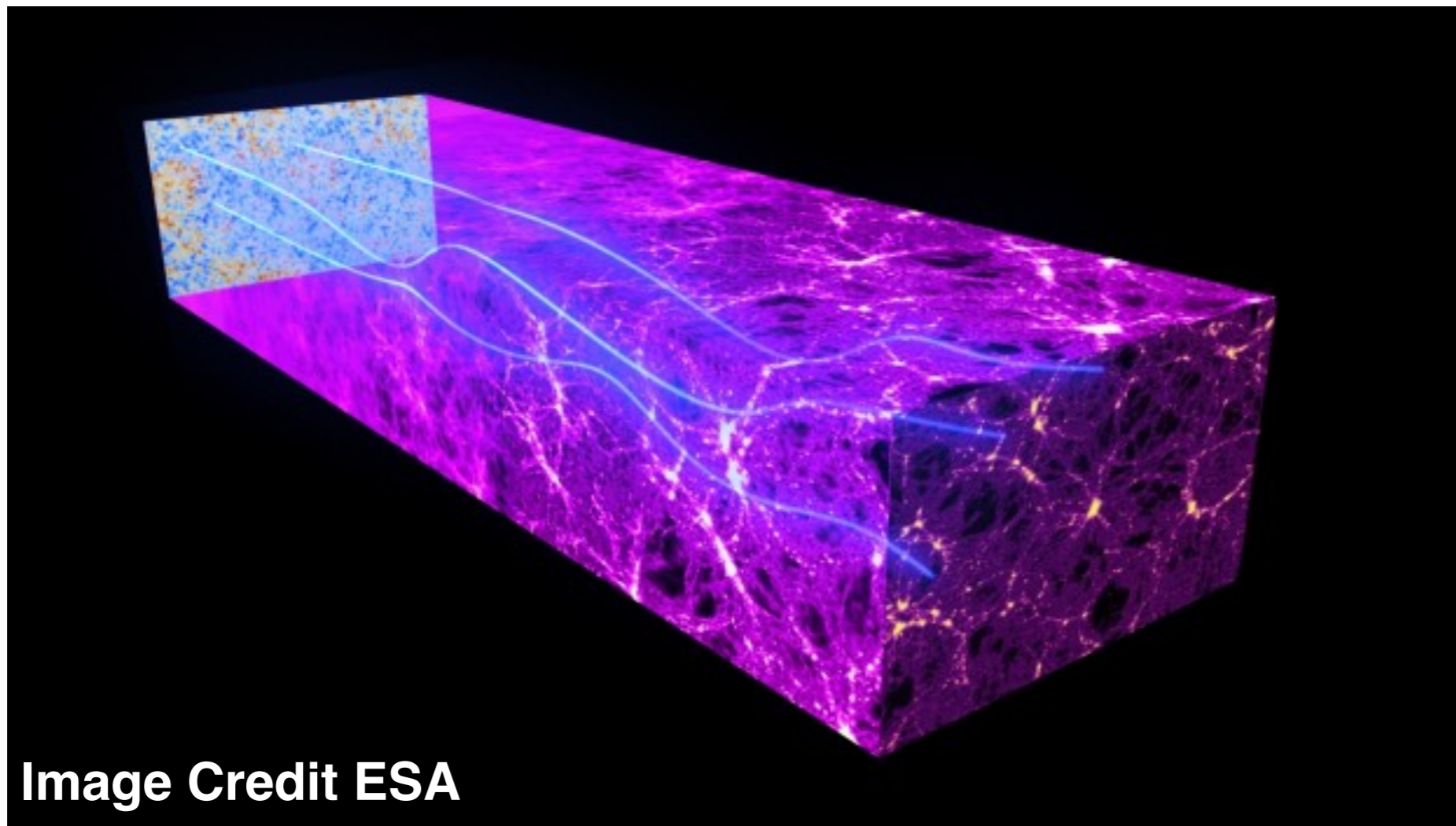

The larger the neutrino mass the less is the CMB light lensed!

Neutrino Masses in Cosmology

Cosmic Microwave Background Anisotropies

The effect of neutrino masses in the CMB:

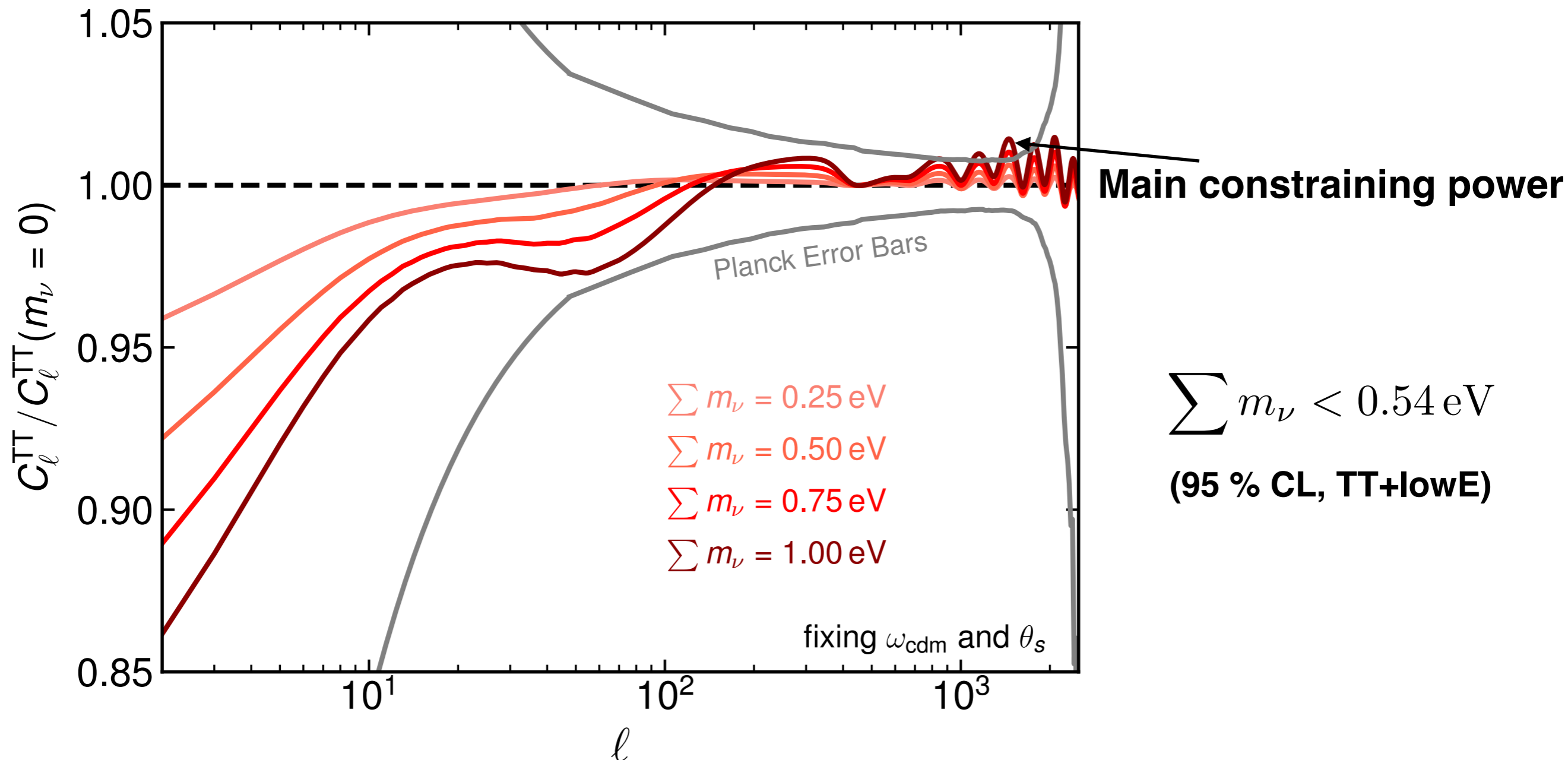

Neutrino Masses in Cosmology

Galaxy Surveys

Suppression from $\Omega_\nu h^2$

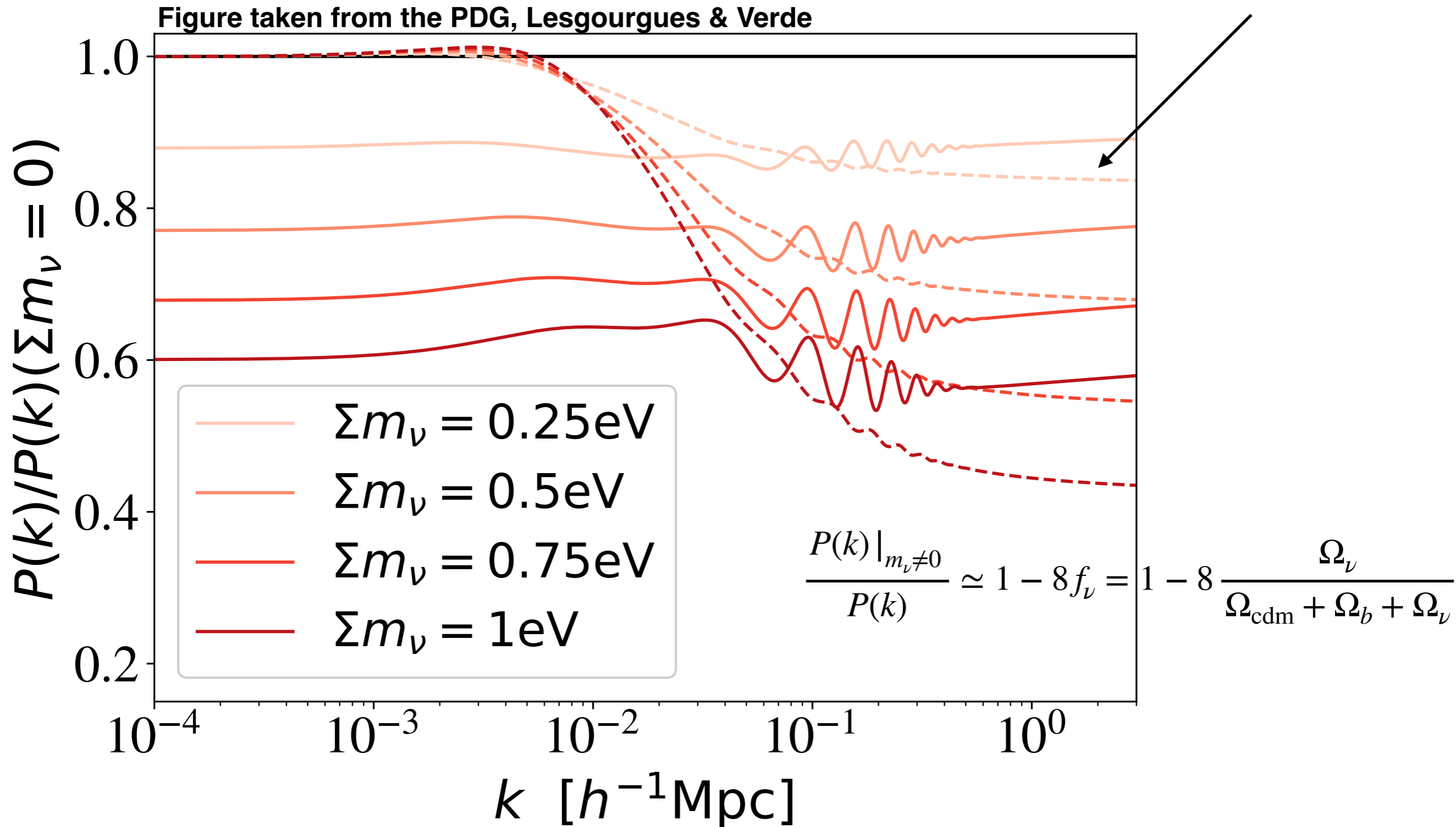

Neutrino Masses from Cosmology

Planck 2018 for Λ CDM (1807.06209)

$$\sum m_\nu < 0.54 \text{ eV} \quad (95 \% \text{ CL, TT+lowE})$$

$$\sum m_\nu < 0.26 \text{ eV} \quad (95 \% \text{ CL, TTTEEE+lowE})$$

$$\sum m_\nu < 0.24 \text{ eV} \quad (95 \% \text{ CL, TTTEEE+lowE+lensing})$$

$$\sum m_\nu < 0.12 \text{ eV} \quad (95 \% \text{ CL, TTTEEE+lowE+lensing+BAO})$$

To be compared to the KATRIN bound: $\sum m_\nu < 2.4 \text{ eV}$

Very robust bounds from linear Cosmology $\Delta T/T \sim 10^{-5}$

What about other non-linear cosmological data?

What about possible systematics in the Planck data?

And, all cosmological bounds are cosmological model dependent

What is the dependence upon the assumed Cosmological Model?

Neutrino Masses from Cosmology

Data beyond Planck and BAO within Λ CDM

$\sum m_\nu < 0.26 \text{ eV}$	Planck	Planck 1807.06209
$\sum m_\nu < 0.12 \text{ eV}$	Planck+BAO	Planck 1807.06209
$\sum m_\nu < 0.86 \text{ eV}$	BOSS P(k)	Ivanov et al. 1909.05277
$\sum m_\nu < 0.16 \text{ eV}$	Planck+BOSS P(k)	Ivanov et al. 1912.08208
$\sum m_\nu < 0.58 \text{ eV}$	Lyman-α+H_0prior	Palanque-Delabrouille et al. 1911.09073
$\sum m_\nu < 0.10 \text{ eV}$	Planck+Lyman-α	Choudhury & Hannestad 1907.12598
$\sum m_\nu < 0.08 \text{ eV}$	Planck+BAO+H_0	di Valentino, Gariazzo & Mena 2106.15267
$\sum m_\nu < 0.09 \text{ eV}$	Planck+BAO+SN+RSD	

- **Planck is driving current cosmological constraints**
- **Non-linear or mildly non-linear data sets break degeneracies in the fit**
- **The larger H_0 is, the stronger the constraint on $\sum m_\nu$ is** (However, this comes from combining two data sets in strong tension!)

Neutrino Masses from Cosmology

Neutrino masses and the Planck lensing anomaly

There is an anomaly in the Planck data at high multipoles which could potentially have relevant implications for the neutrino mass constraints

This tension (3σ) is parametrized in terms of the A_L parameter, which is an *unphysical parameter* modifying the amplitude of the lensing spectrum!

Importantly, the Planck collaboration claims that the most likely origin of this tension is a statistical fluctuation:

1807.06209

Planck 2018 results. VI. Cosmological parameters

If the $A_L > 1$ preference is simply a statistical excursion (perhaps the most likely explanation), this indicates that there are random features in the spectrum that are pulling some parameters unusually far from expected values.³⁰ There are several

In addition, more recent analyses of the Planck data do point in that direction:

see Rosenberg, Gratton & Efstathiou 2205.10869

The lower noise of the NPIPE maps leads to tighter parameter constraints, with a $\sim 10\%$ improvement in most Λ CDM parameters in TTTEEE due primarily to improvements in polarization. For Λ CDM extensions we find that, relative to PR3, NPIPE polarization shrinks the error bars on Ω_K and A_L from EE by 40% and 25% respectively, and by 15% and 8% in TTTEEE. That these smaller error bars are accompanied by shifts toward the Λ CDM values continues the trend observed in EG21 of decreasing the Ω_K and A_L tensions as more data is used, as would be expected if these pulls were due to a statistical fluctuation. Overall, we conclude that NPIPE, despite

Finally, even in the presence of this anomaly the effect on the neutrino mass bound is expected to be of only 20% within Λ CDM!

Motloch and Hu 1912.06601

As is well known, the Planck lensing-like anomaly strengthens neutrino mass constraints. When combining Planck data with current BAO and SN data, we find that the lensing-like anomaly improves the neutrino mass constraints by less than 20%. Additionally allowing nonzero curvature further degrades this constraint by only about 10%. We find that when considering either PP or BAO+SN on top of Planck temperature and polarization power spectra, the data are consistent with flat Universe and this preference is not affected by the lensing anomaly.

Neutrino Masses from Cosmology

Cosmological Model Dependence

Planck+BAO and 3 degenerate neutrinos

$$\sum m_\nu < 0.12 \text{ eV}$$

Standard Case

Planck 1807.06209

Λ CDM+m_ν

$$\sum m_\nu < 0.25 \text{ eV}$$

Dark Energy dynamics

Choudhury & Hannestad 19'

CDM+m_ν+ω_a+ω

$$\sum m_\nu < 0.15 \text{ eV}$$

Varying Curvature

Choudhury & Hannestad 19'

Λ CDM+m_ν+Ω_k

$$\sum m_\nu < 0.13 \text{ eV}$$

Varying N_{eff}

Planck 1807.06209

Λ CDM+m_ν+N_{eff}

$$\sum m_\nu < 0.17 \text{ eV}$$

Varying N_{eff}+ω+a_s+m_ν

di Valentino et al. 1908.01391

CDM+m_ν+N_{eff}+ω+a_s+m_ν

- **Constraints are robust upon standard modifications of Λ CDM**

Neutrino Masses from Cosmology

Cosmological Model Dependence

Non-standard Neutrino Cosmologies:

Invisible Neutrino Decay

$$\nu_i \rightarrow \nu_j \phi$$
$$\sum m_\nu \lesssim 0.2 \text{ eV}$$

Oldengott, Wong et al. 2203.09075 & 2011.01502
Escudero & Fairbairn 1907.05425

Time Dependent Neutrino Masses

Late phase transition

$$\sum m_\nu < 1.4 \text{ eV}$$

Dvali & Funcke 1602.03191
Lorenz et al. 1811.01991 & 2102.13618

Non-standard Neutrino Populations

$$T_\nu < T_\nu^{\text{SM}} + \text{DR}$$

$$\sum m_\nu < 3 \text{ eV}$$

Farzan & Hannestad 1510.02201
Renk et al. 2009.03286

$$\nu_i \rightarrow \nu_4 \phi$$

$$\sum m_\nu \lesssim 0.42 \text{ eV}$$

Poulin et al. 1909.05275, 2112.13862
Escudero, López-Pavón, Rius & Sandner 2007.04994

Ultralight scalar field screening

$$\sum m_\nu < 3 \text{ eV}$$

Esteban & Salvadó 2101.05804
Wetterich et al. 1009.2461

$$\langle p_\nu \rangle > 3.15 T_\nu^{\text{SM}}$$

$$\sum m_\nu < 3 \text{ eV}$$

Oldengott et al. 1901.04352
Alvey, Escudero & Sabti 2111.14870

- **Bounds can significantly loosen in some extensions of Λ CDM. They require modifications to the neutrino sector.**

But Why? and How?

Neutrino Masses from Cosmology

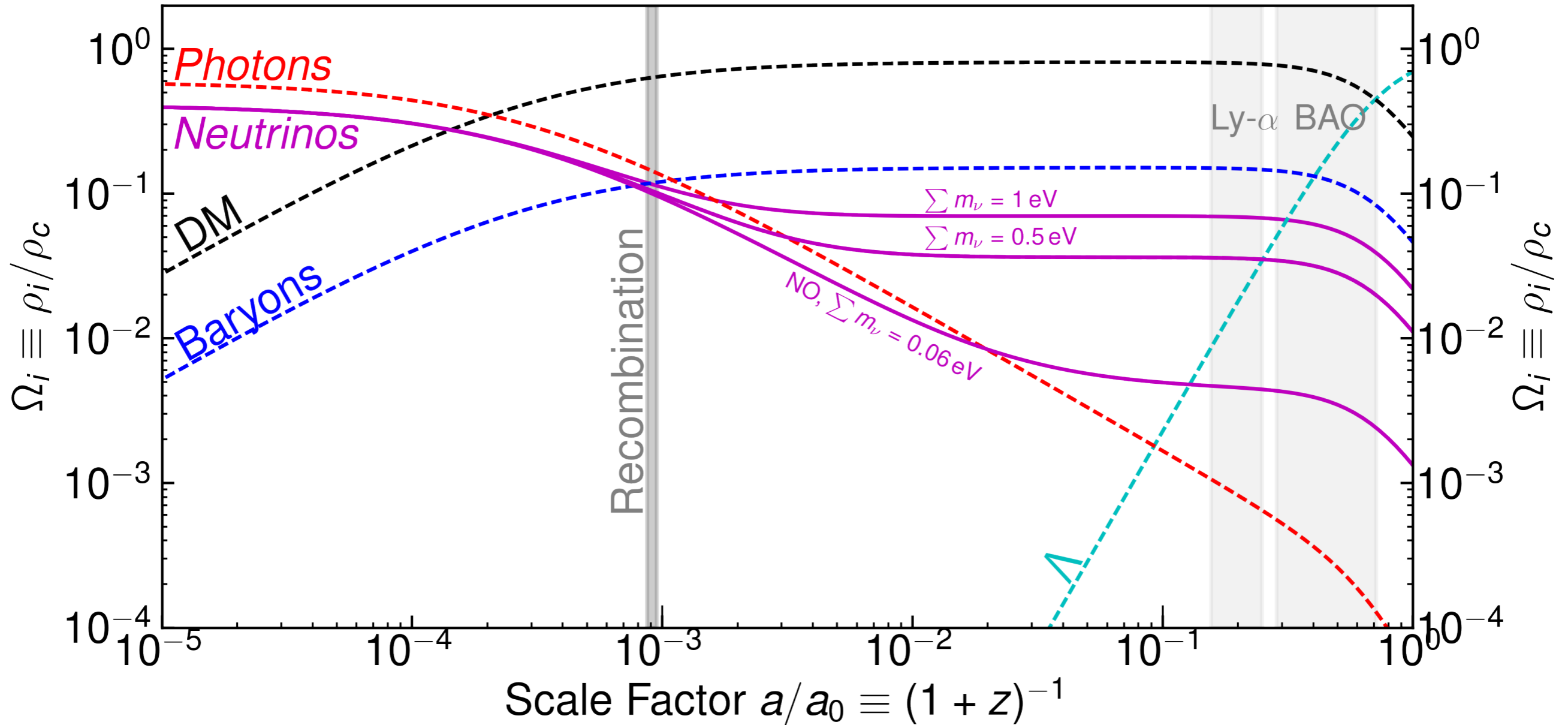

CMB peaks fix:

$$\theta_s \equiv r_s / D_M(z_*)$$

$$r_s = \int_{z_*}^{\infty} \frac{c_s}{H(z')} dz'$$

**Comoving sound horizon
(Early Universe)**

$$D_M(z) = \int_0^z \frac{1}{H(z')} dz'$$

**Comoving angular diameter distance
(Late Universe)**

Massive neutrinos →

Neutrino Masses from Cosmology

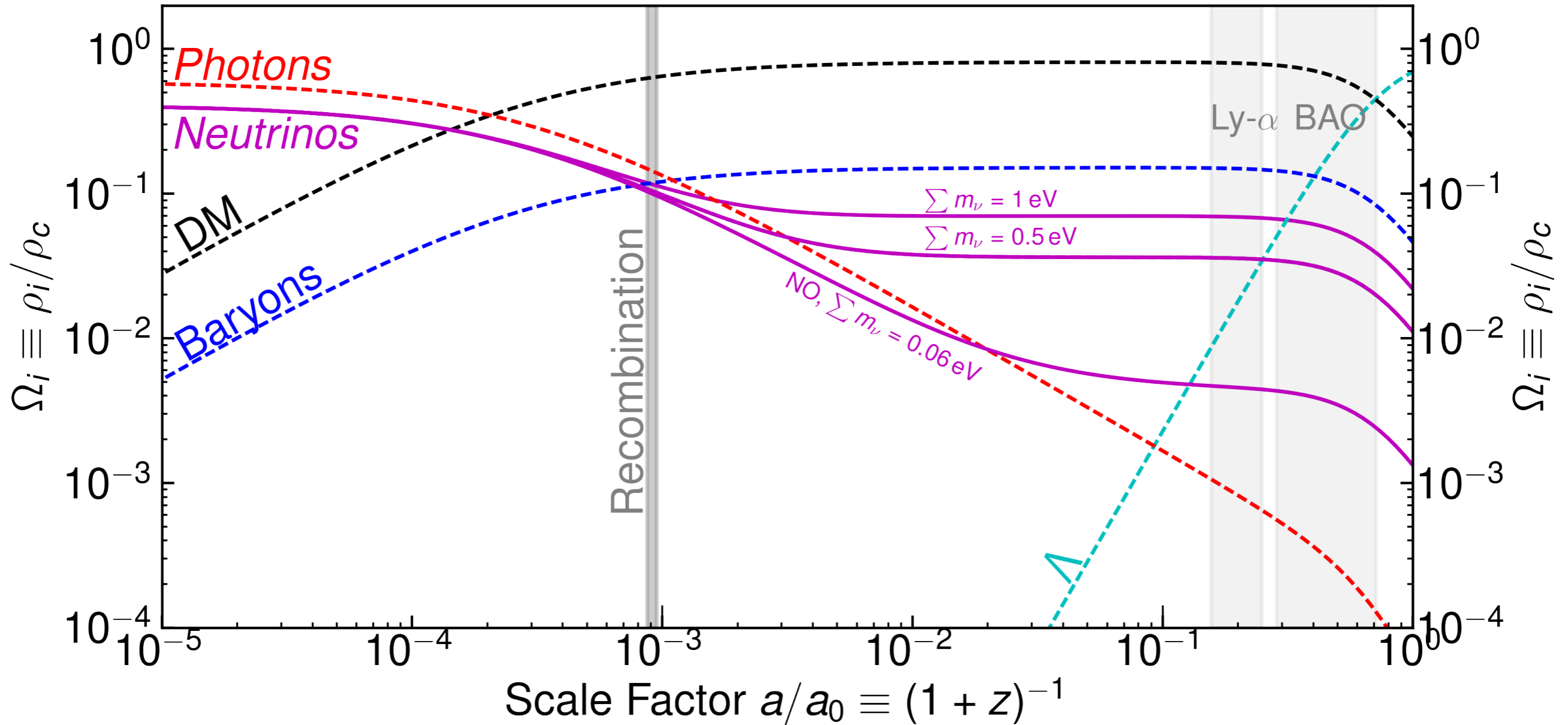

Not only a background effect:

Massive neutrinos also affect CMB lensing $\propto \Omega_\nu$

Neutrino Decays

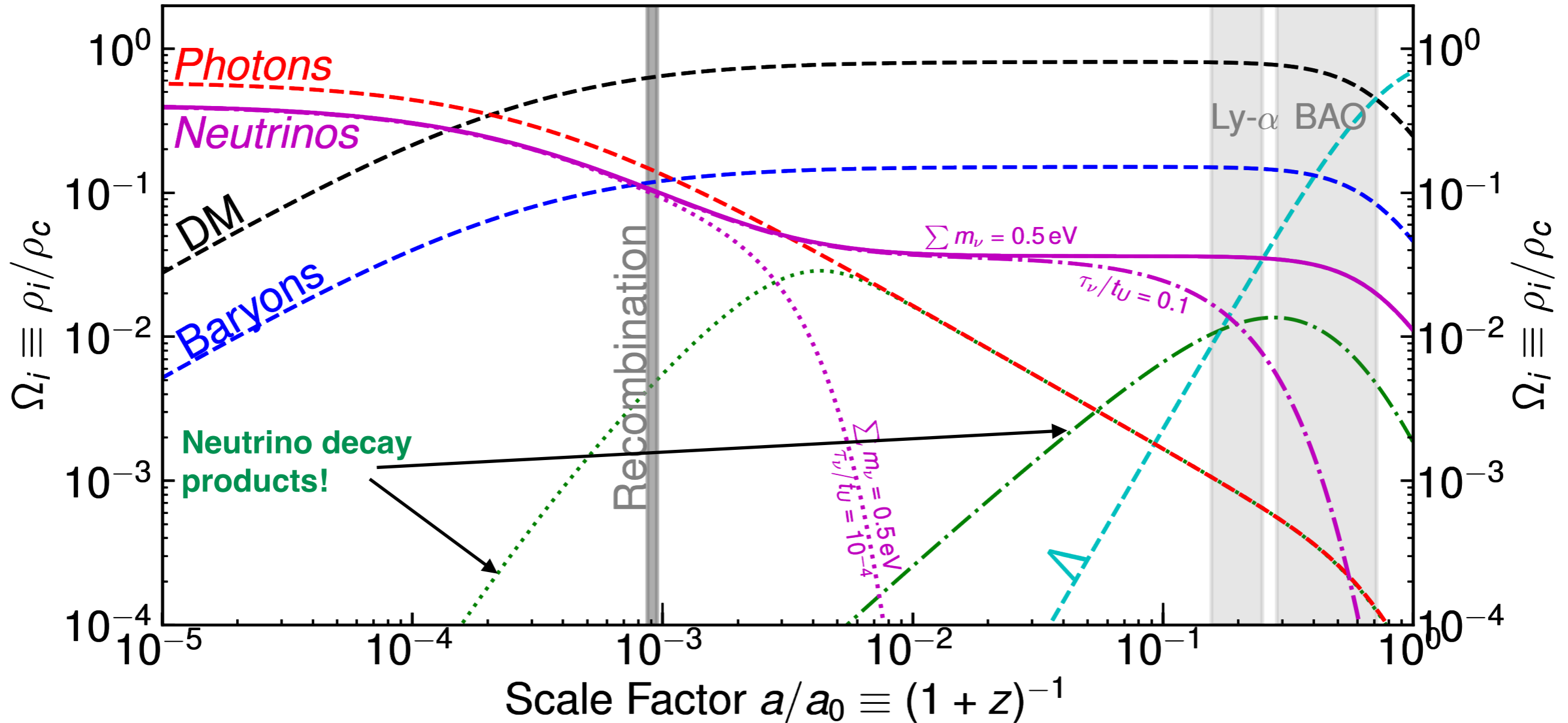

Neutrinos decaying with $\tau_\nu \lesssim t_U/10$ do not impact $D_M(z_{\text{CMB}})$

Effect of induced neutrino Lensing is substantially reduced

Unstable Neutrinos can relax the bounds on Σm_ν !

Neutrino Masses from Cosmology

Non-standard Neutrino Cosmologies:

Invisible Neutrino Decay

$$\nu_i \rightarrow \nu_j \phi$$
$$\sum m_\nu < 0.2 \text{ eV}$$

Oldengott, Wong et al. 2203.09075 & 2011.01502
Escudero & Fairbairn 1907.05425

$$\nu_i \rightarrow \nu_4 \phi$$
$$\sum m_\nu \lesssim 0.42 \text{ eV}$$

Poulin et al. 1909.05275, 2112.13862
Escudero, López-Pavón, Rius & Sandner 2007.04994

Time Dependent Neutrino Masses

Late phase transition

$$\sum m_\nu < 1.4 \text{ eV}$$

Dvali & Funcke 1602.03191
Lorenz et al. 1811.01991 & 2102.13618

Ultralight scalar field screening

$$\sum m_\nu < 3 \text{ eV}$$

Esteban & Salvadó 2101.05804
Esteban, Mena & Salvadó 2202.04656

Non-standard Neutrino Populations

$$T_\nu < T_\nu^{\text{SM}}$$

$$\sum m_\nu < 3 \text{ eV}$$

Farzan & Hannestad 1510.02201
Renk et al. 2009.03286

$$\langle p_\nu \rangle > 3.15 T_\nu^{\text{SM}}$$

$$\sum m_\nu < 3 \text{ eV}$$

Oldengott et al. 1901.04352
Alvey, Escudero & Sabti 2111.14870

Take Away Messages:

- Cosmology can only constrain $\Omega_\nu(z)$ and not directly m_ν
- Of course, in Λ CDM there is a direct link between $\Omega_\nu(z)$ and m_ν
- All these models reduce $\Omega_\nu(z)$ with respect to the one in Λ CDM and are in excellent agreement with all known cosmological data
- Importantly, they entail non-standard neutrino properties

Summary I: CNB

Number of effective neutrino species

$$N_{\text{eff}}^{\text{BBN}} = 2.86 \pm 0.28 \quad N_{\text{eff}}^{\text{CMB}} = 2.99 \pm 0.17$$

$$N_{\text{eff}}^{\text{SM}} = 3.044(1)$$

Agreement between measurements of N_{eff} and the SM prediction implies:

Strong evidence that the CNB should be there as expected in the SM

Allows us to set constraints on key neutrino properties

Summary II: Neutrino Masses

Neutrino Masses:

Cosmological bounds are very stringent within the standard cosmological model, Λ CDM:

$$\sum m_\nu < 0.12 \text{ eV}$$

However, all cosmological neutrino mass bounds are cosmological model dependent

There are several non-standard cosmologies where this bound can be evaded. *These models are exotic*, but current data cannot differentiate them wrt Λ CDM

Outlook: Number of Neutrinos

The next generation of CMB experiments are expected to significantly improve the sensitivity on N_{eff} .

Simons Observatory



CMB-S4

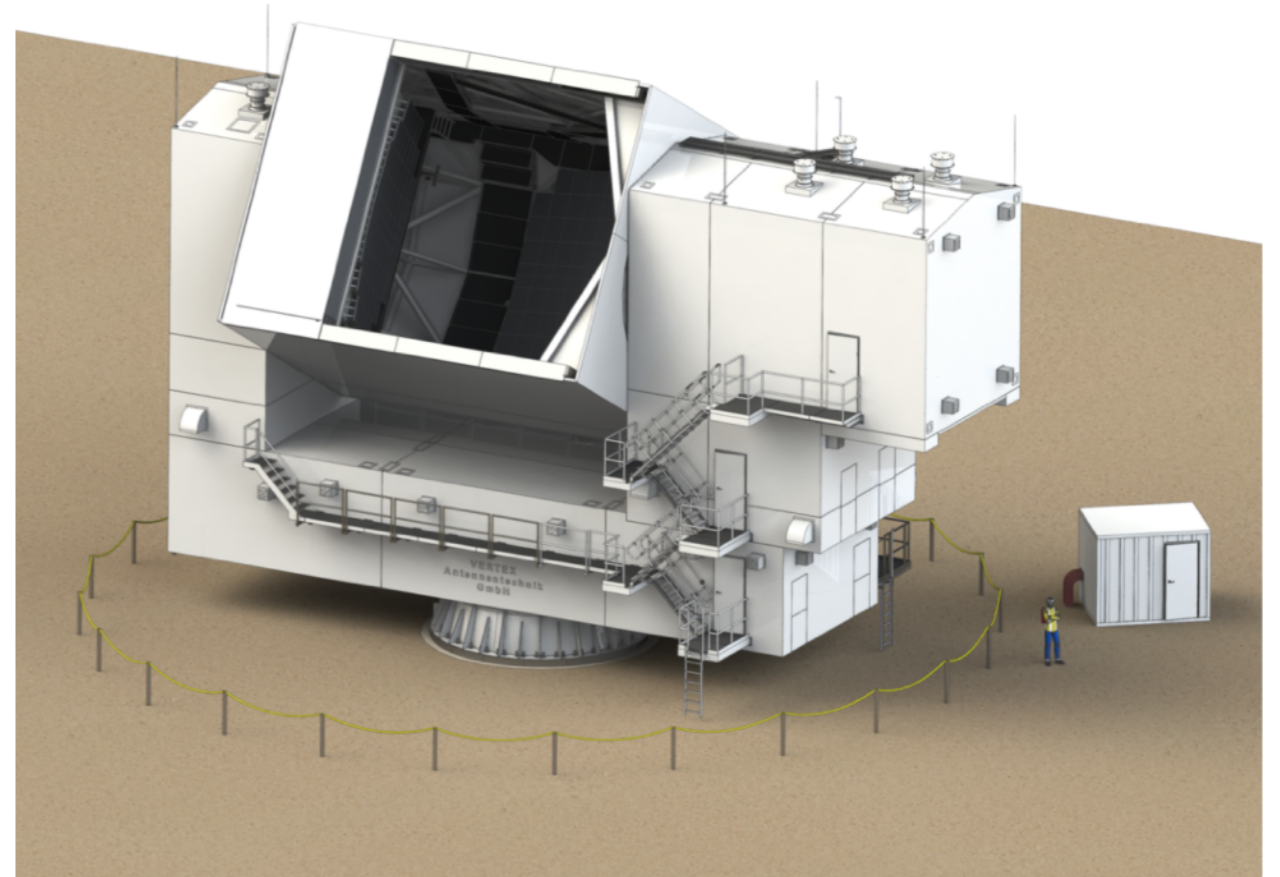

$$\sigma(N_{\text{eff}}) = 0.06 \sim 2028$$

$$\sigma(N_{\text{eff}}) = 0.03 \sim 2035?$$

These measurements will represent an important test of the CNB in the SM and perhaps may yield a BSM signal!

Outlook: Neutrino Masses

The next generation of galaxy surveys in combination with CMB data are expected to measure the neutrino mass if the Universe is governed by a Λ CDM cosmology.

DESI

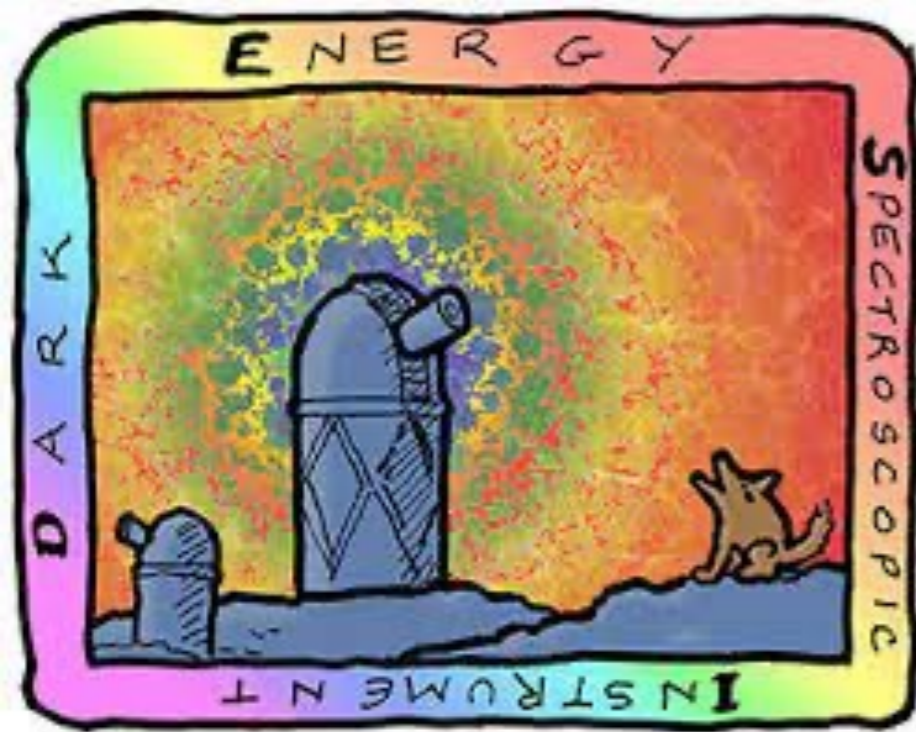

EUCLID

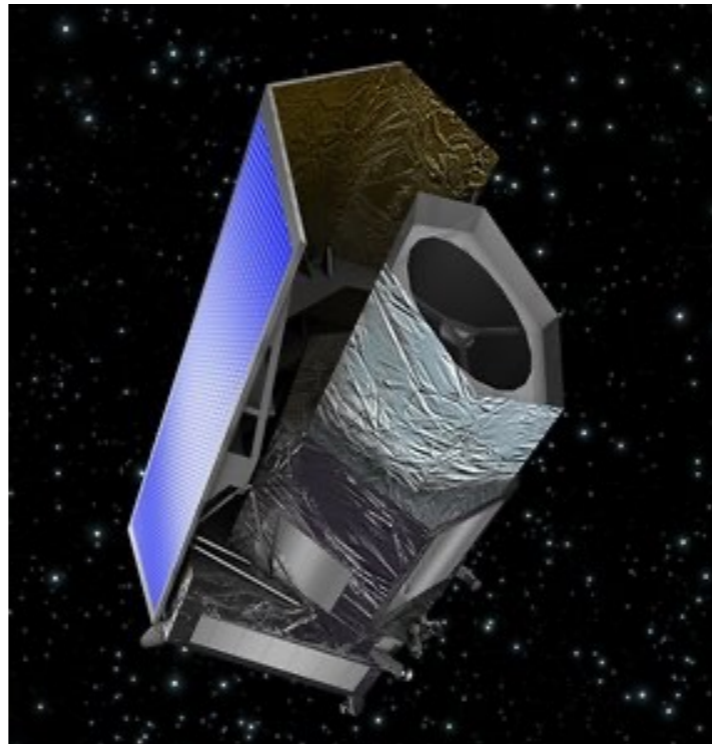

LiteBIRD

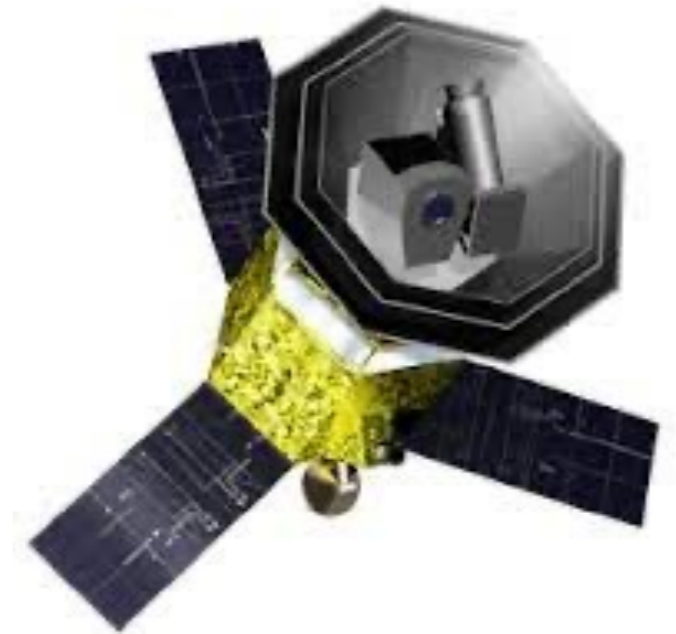

Why? DESI: 30M galaxies and EUCLID: 50M galaxies, but BOSS 0.5M galaxies

This is expected to happen in the next 5-7 years: $\sigma(\sum m_\nu) = 0.02$

In parallel, the KATRIN experiment is taking data and should reach a sensitivity of $m_{\bar{\nu}_e} \lesssim 0.2 \text{ eV}$ at 90% CL in ~ 4 years.

Take Home Messages

- 1) In the Standard Model, neutrinos are always a relevant component of the Universe across its entire history**
- 2) We have indirect (albeit strong) evidence that the Cosmic Neutrino Background should be there**
- 3) Current cosmological constraints are very stringent and are dominated by Planck data**

$$\sum m_\nu < 0.12 \text{ eV}$$

- 4) To significantly relax this bound one should invoke non-standard neutrino properties in cosmology**

Global Perspective

Neutrinos in the SM:

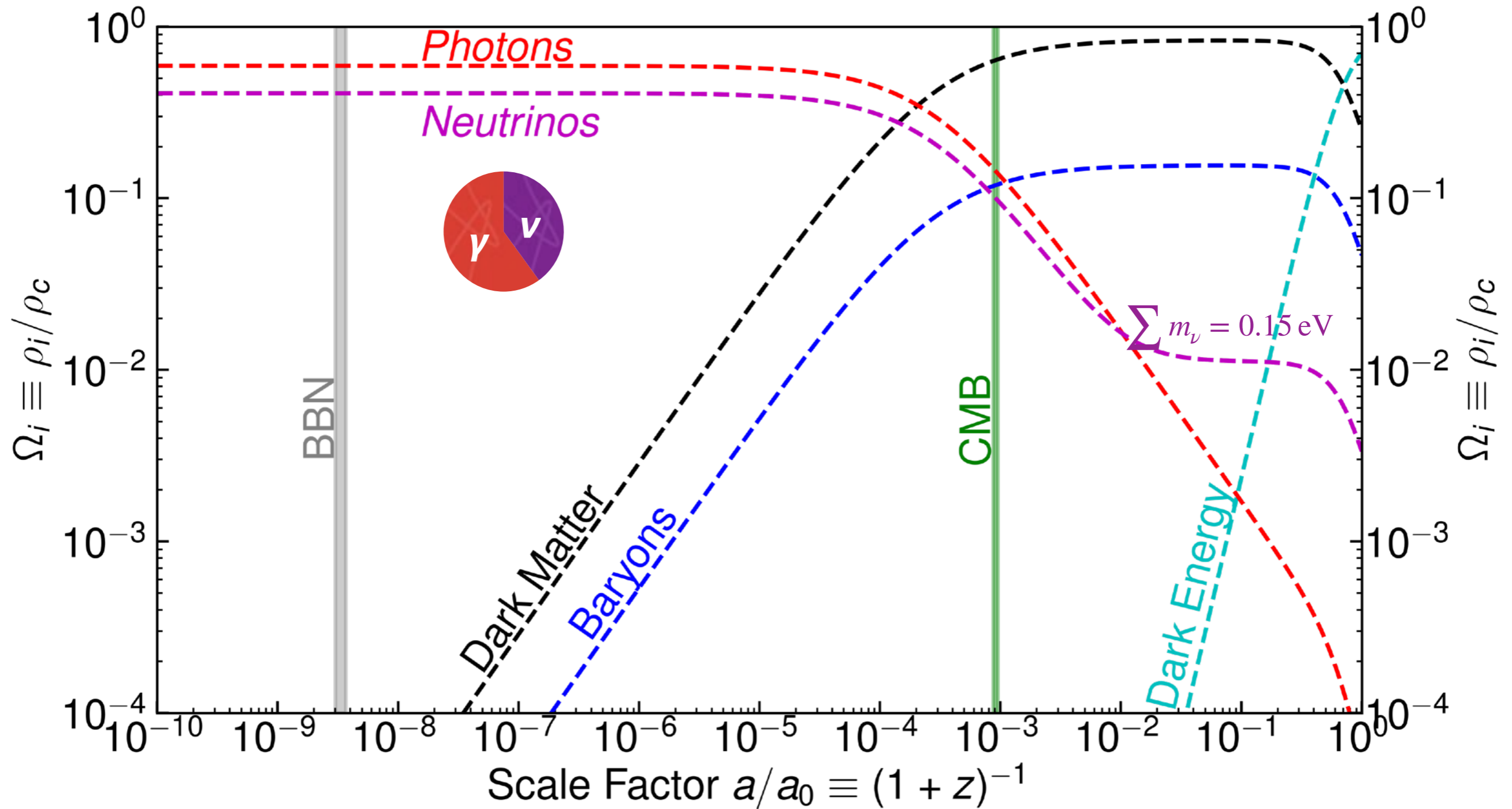

Global Perspective

Current knowledge:

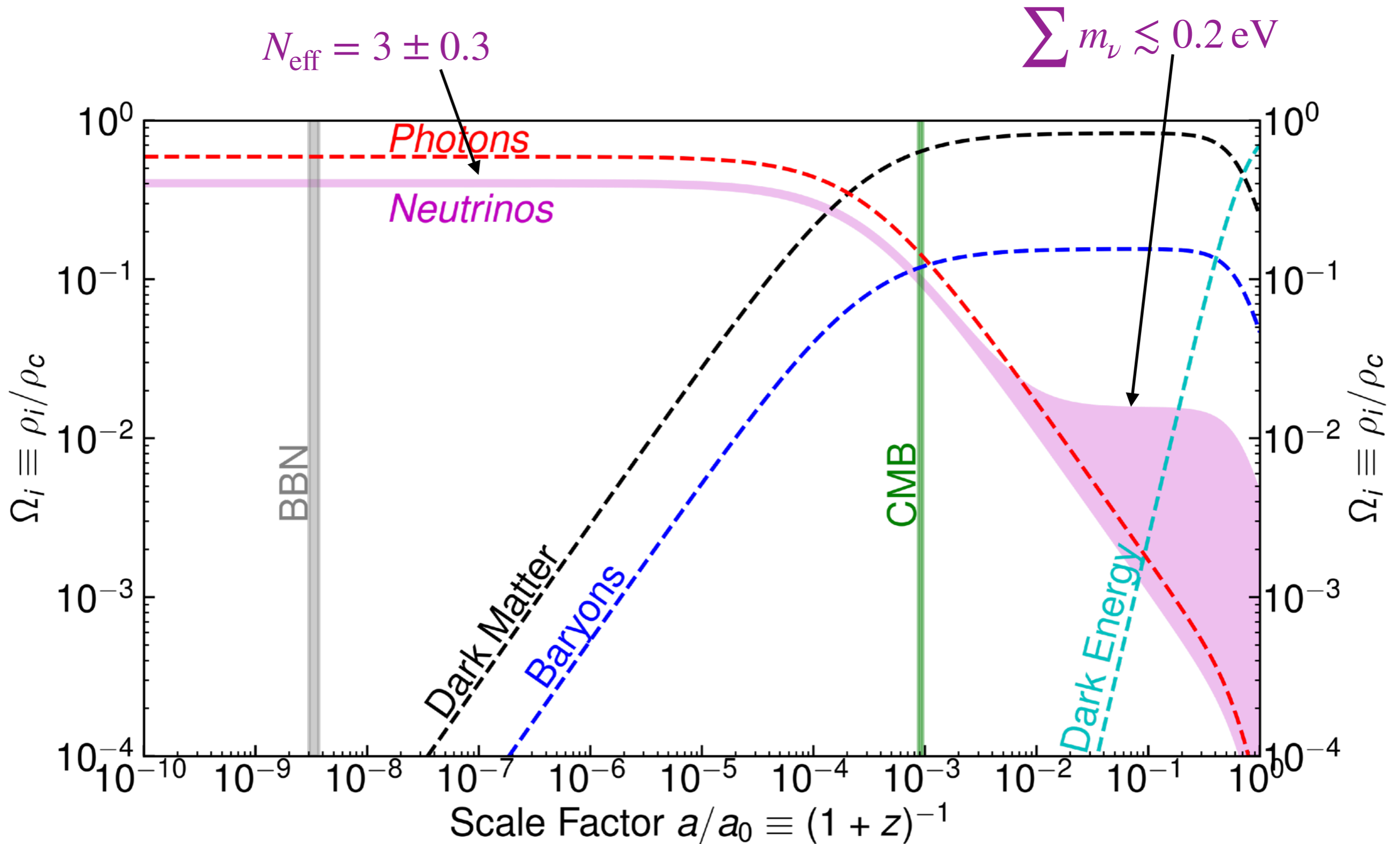

Global Perspective

In the next 5-6 years:

$$N_{\text{eff}} = 3.044 \pm 0.06$$

$$\sum m_\nu = 0.06 \pm 0.02 \text{ eV}$$

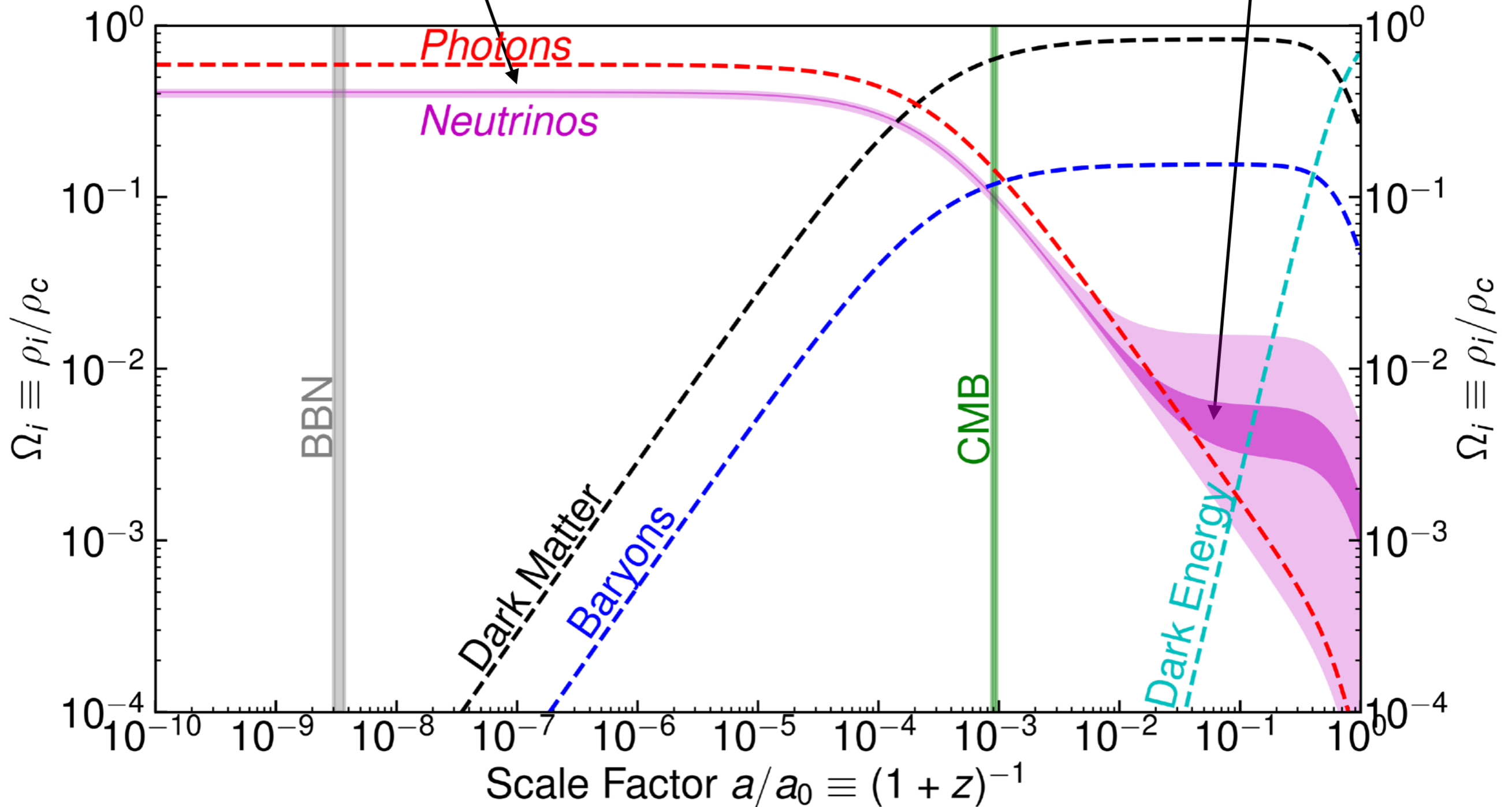

Global Perspective

I think we are living exciting times in Cosmology

In particular in Neutrino Cosmology:

We expect to detect the neutrino mass in 5-6 years!



Thank you for your attention!

miguel.escudero@cern.ch